

Masszeichnung

COOL-LINE Vitrine KRISTALL 120 UM

[Art. 506050120]

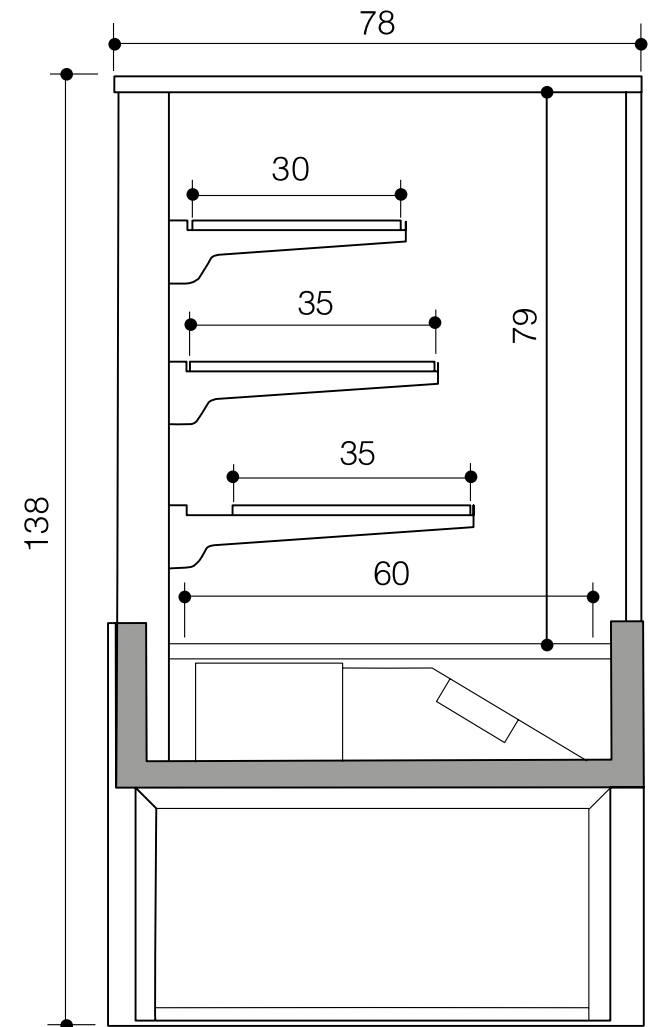
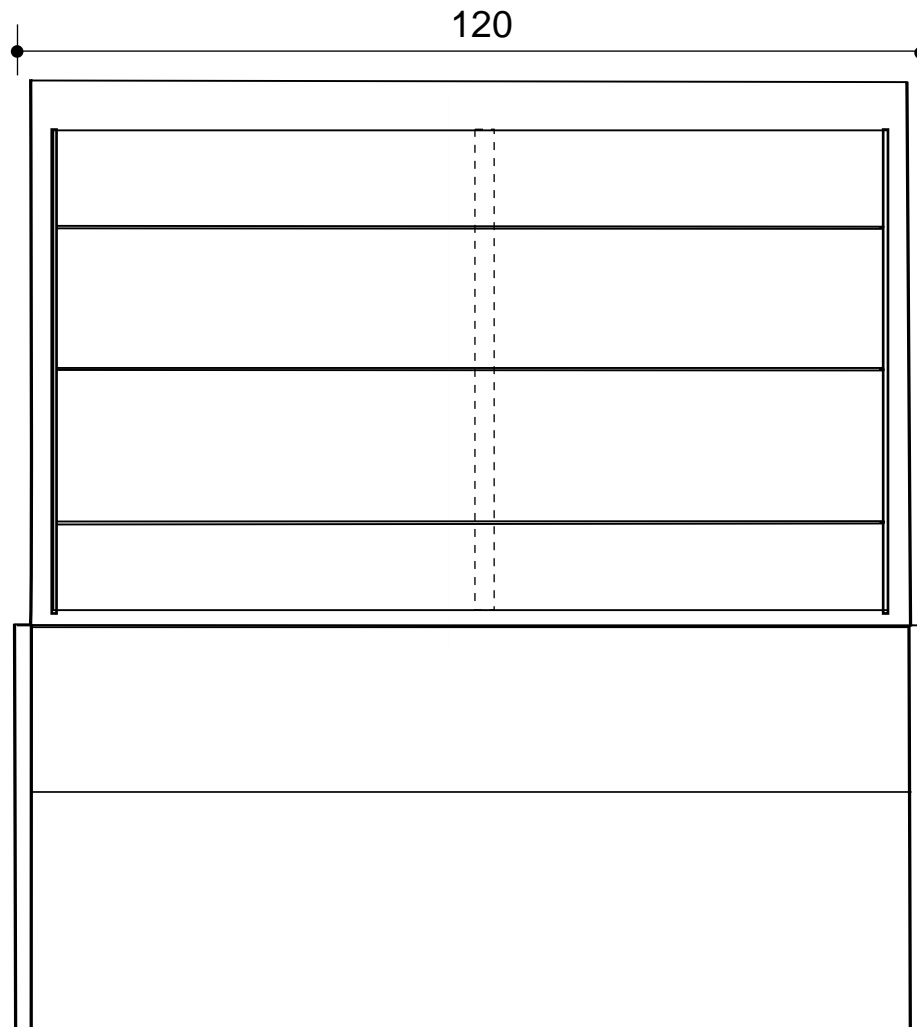

* Alle Angaben in cm