



Bei der Entwicklung des Thermocook greift Neumärker auf die jahrzehntelange Erfahrung mit der Fertigung professioneller Gastronomieräte zurück. Die Konstruktion aus beständigen Materialien und die Made in Germany Manufakturqualität bietet dem Anwender ein Arbeitsgerät von höchster Zuverlässigkeit, auf das er sich über viele Jahre hinweg verlassen kann. Das Herzstück des Thermocook ist die solide Mechanik des Wechsellattensystems. Mithilfe von acht Schrauben aus Edelstahl werden die massiven Gussplatten gleichmäßig auf den Heizkörper gespannt. So entsteht eine optimale Wärmeübertragung auf der gesamten Fläche für kurze Garzeiten und perfekte Ergebnisse.

For the development of the Thermocook, Neumärker can draw on decades of experience in manufacturing professional appliances to meet the special requirements of the catering industry. The construction from durable materials and the quality of workmanship made in Germany offers the user a highly reliable tool that they can rely on for many years to come. Core element of the Thermocook is the solid mechanism of the interchangeable plate system. Eight stainless steel screws are used to clamp the solid plates directly onto the heating element. The tightening creates an even heat transfer for short cooking times and perfect results.



DEUTSCHE
MANUFAKTUR
handmade in germany



Digitaltimer mit großem Display und Signalton

Sekundengenau einstellbar: Der Anwender wird zum richtigen Zeitpunkt daran erinnert, die Speisen zu entnehmen, so dass diese nicht anbrennen, während er parallel anderen Tätigkeiten nachkommt.

Digital timer with large display and acoustic signal. Adjustable to the second: The acoustic signal reminds the user at the right time to remove the food so that it does not burn while they are performing other tasks at the same time.



Massive Scharniere aus Guss

Die Scharniere sind Teil der massiven Gussplatten und tragen mühelos das Gewicht.

The hinges are part of the solid cast metal plates and carry the weight without any effort.



Manufakturqualität in jedem Detail

Die Schrauben aus rostfreiem Edelstahl lassen sich einfach von Hand lösen.

Manufactory quality in every detail. The stainless steel screws can be easily loosened by hand.



Handgeprägtes Logo als Qualitätssiegel

Das von Hand geprägte Logo steht für die herausragende Manufakturqualität unserer Geräte.

The embossed logo symbolises the outstanding manufacturing quality of our appliances.

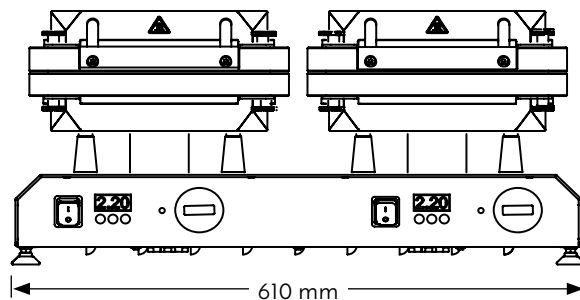
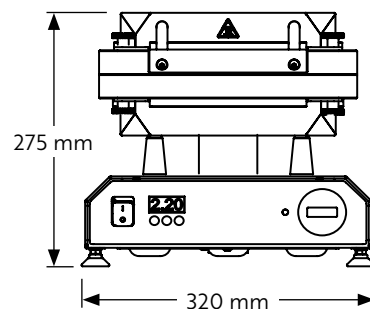
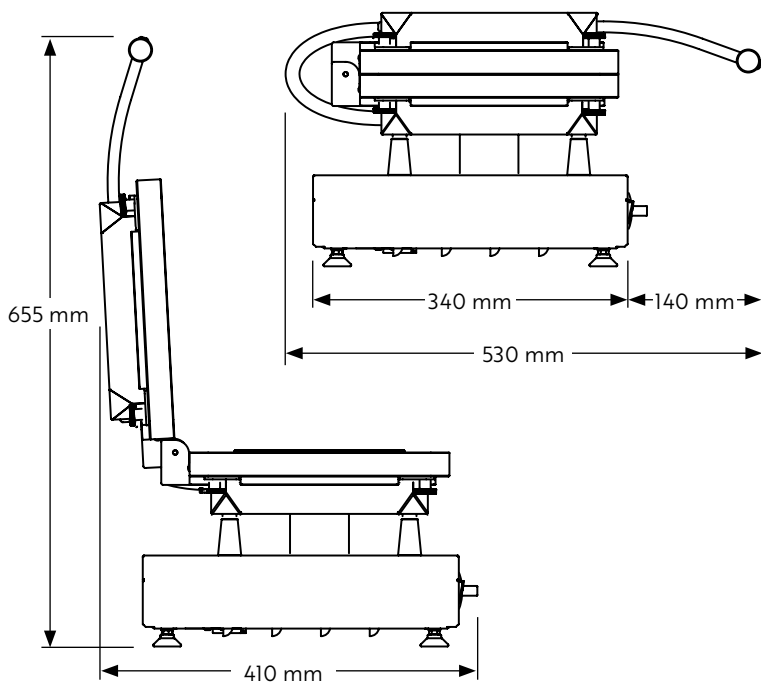

Hochwertiger Abstandshalter aus gedrehtem Aluminium

Ermöglicht die thermische Entkopplung und verlängert somit die Lebenszeit des Produktes. Die gut erreichbaren Oberflächen lassen sich einfach reinigen.

High-quality turned spacer made of solid aluminium. The spacer prevents heat accumulation in the appliance and thus extends its service life. The easily accessible surfaces are easy to clean.



Stabiler Griff aus Edelstahl und Polyamid

Der fest verankerte Griff besteht aus Edelstahlrohr und hitzebeständigem Polyamid. Zwei robuste Materialien, die für ihre Langlebigkeit bekannt sind.

Sturdy handle made of stainless steel and polyamide. The firmly anchored handle is made of stainless steel tubing and heat resistant polyamide. Two materials that are known for their durability.



THERMOCOOK®



**DIE WELT
DER SNACK-
GASTRONOMIE
IN EINEM GERÄT**

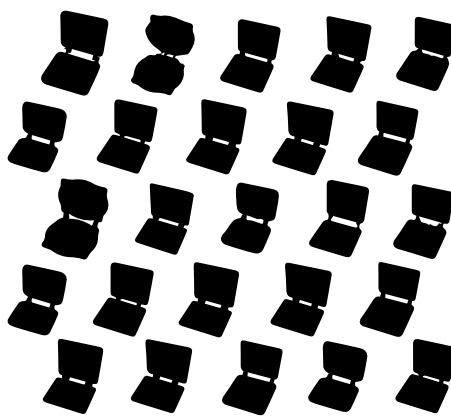

**ÜBER 25
VERSCHIEDENE
WECHSELPLATTEN.
MORE THAN 25
INTERCHANGEABLE
PLATES.**

**THE WORLD
OF SNACK
CATERING IN
ONE DEVICE**



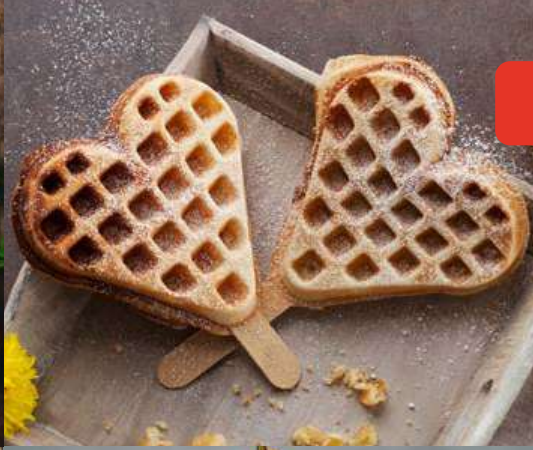

THERMOCOOK®



Thermocook®

Multifunktionsgerät für auswechselbare Platten (nicht im Lieferumfang enthalten) • Aktuell über 25 verschiedene Wechselplatten erhältlich, z.B. für Waffeln, Pizza, Crêpes, Paninis, Pancakes, Donuts, Sandwiches, Churros u.v.m • Digitaltimer mit großem Display einstellbar bis 9:59 Min/Sek • Ein Signalton am Ende der Zubereitungszeit gewährleistet beständige Produktqualität, auch bei wechselndem Personal • Durch das akustische Signal wird der Anwender zum richtigen Zeitpunkt daran erinnert, die Speisen zu entnehmen, so dass diese nicht anbrennen, während er parallel anderen Tätigkeiten nachkommt • Optimale Hitzeübertragung: Direkter Kontakt zwischen Heizkörper zur Wechselplatte durch 8 Schrauben, die gleichmäßig angezogen werden • Neue, leistungsstärkere Spezialheizkörper mit vergrößerter Heizfläche für eine gleichmäßige Wärmeübertragung ohne Hotspots • Besonders energieeffizient durch optimierte Wärmeisolierung: Eine doppelte Abschirmung minimiert Wärmeverluste und reduziert die Gefahr schwerer Verbrennungen • Äußerst stabile Rahmenkonstruktion durch verstärkte Stützleisten • Der Abstand von 42 mm zwischen den heißen Platten und dem Gehäuse ermöglicht die thermische Entkopplung und verlängert somit die Lebenszeit des Produktes • Verbesserte Lüftungsschlitze gewährleisten den Wärmeaustausch im Gehäuse • Einfache Reinigung der leicht erreichbaren Oberflächen • Besonders servicefreundliche Konstruktion für eine einfache Wartung und Reparatur • Frontpanel mit Display aus pflegeleichtem und langlebigem Autotex Polyester • Thermostatische Regelung 0 - 300°C • Kontrollleuchte • Ein-/Ausschalter • Gehäuse Edelstahl • Höhenverstellbare Füße

**NEU
NEW**



Multifunction appliance for interchangeable plates (not included) • Currently more than 25 different interchangeable plates available, e.g. for waffles, pizza, crêpes, paninis, pancakes, donuts, sandwiches, churros • Digital timer with large display adjustable up to 9:59 min/sec • An acoustic signal at the end of the cooking time ensures consistent product quality, even with frequently changing staff • The acoustic signal reminds the user at the right time to remove the food so that it does not burn while they are performing other tasks at the same time • Optimal heat transfer: Direct contact between heating element and interchangeable plate due to 8 screws that are tightened evenly • New high-performance heating elements with enlarged heating surface for even heat distribution without hotspots • Particularly energy-efficient through optimised thermal insulation: A double shielding minimises heat loss and reduces the risk of serious burns • Extremely stable frame construction thanks to reinforced supports • The space of 42 mm between the hot plates and the casing prevents heat accumulation in the appliance and thus extends the service life • Improved ventilation slots ensure heat exchange in the casing • Easy cleaning of the accessible surfaces • Particularly service-friendly design for easy maintenance and repair • Front panel with display made of easy-to-clean and durable Autotex polyester • Thermostatic control 0 - 300°C • Pilot light • On/off switch • Stainless steel casing • Height-adjustable feet

Thermocook	1	230 V	2,8 kW	50/60 Hz	320 x 340/530 x 275/655 mm	9,5 kg	12-40801DT	699,-*
Thermocook Twin	2	400 V	5,6 kW	50/60 Hz	610 x 340/530 x 275/655 mm	17,9 kg	12-40802DT	1448,-*
Thermocook Twin 2x 230V	2	2x 230 V	2x 2,8 kW	50/60 Hz	610 x 340/530 x 275/655 mm	18,2 kg	12-40802DT-D	1448,-*

**NEU
NEW**



Wechselplatten-Adapter-Set für Backsystem Interchangeable Plates Adapter Set for Baking System

Adapter-Set zur Verwendung von Thermocook Wechselplatten auf dem Neumärker Backsystem • Sie besitzen bereits ein Neumärker Backsystem? Mit dem Adapter-Set können Sie auch weiterhin neue Wechselplatten auf Ihrem Gerät einsetzen • Kompatibel mit fast allen Wechselplatten für den Thermocook • Kompatibel mit Neumärker Backsystem I + II (Art.No. 12-40701DT + 12-40702DT) • Beinhaltet 2 Kegel, 2 Spacer, 4 Schrauben • Je nach Modell der Wechselplatte wird der Kegel mit der kurzen Schraube verwendet oder der Kegel mit Spacer und der langen Schraube • Das Adapter-Set wird nicht für die Anwendung auf dem Neumärker Thermocook benötigt

Adapter set for using Thermocook interchangeable plates on the Neumärker Baking System • Do you already have a Neumärker baking system? With the adapter set, you can still use new interchangeable plates on your device • Compatible with most interchangeable plates for the Thermocook • Compatible with Neumärker baking system I + II (art. no. 12-40701DT + 12-40702DT) • Includes 2 cones, 2 spacers, 4 screws • Depending on the model of the interchangeable plate, the cone with the short screw is used or the cone with spacer and the long screw • The adapter set is not required for use on the Neumärker Thermocook

88-40701-00

€ 25,-* ▲



Waffel-Burger

Waffle Burger

Lust auf einen hippen Waffel-Burger? Nichts leichter als das! Vollmilchschokolade, weiße Schokolade und einen Schokokuss stapeln, ein paar Streusel und Karamelloße drüber: Fertig ist der Schoko-Burger! Oder doch lieber einen Erdbeer-Cheeseburger mit Frischkäse?! Obst-Burger? Oder eine süße Versuchung mit Eis und Sahne?

Fancy a luscious waffle burger? Easy as pie! Stack some slices of dark and white chocolate with chocolate marshmallows, add some sprinkles and caramel sauce on top: There's your Chocolate Burger! Or do you prefer a Strawberry-Cheeseburger with cream cheese?! Fruit Burger? Or a sweet ice cream temptation?

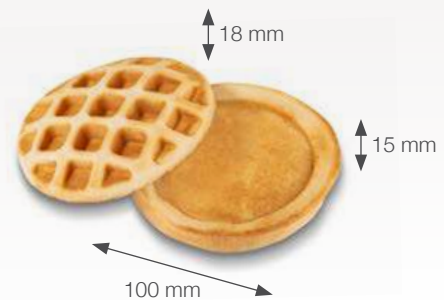

Waffel-Burger Wechsellplatten

Waffle Burger Interchangeable Plates

Kompatibel mit Thermocook. Adapter für Backsystem auf Seite 26.

Compatible with Thermocook. Adapter for Baking System on page 26.

 (2x) Ø 100 x 18/15 mm

 Antihafbeschichtetes Aluminium
Non-stick coated aluminium

 5,3 kg

 31-40778-01

 299,-* ▲

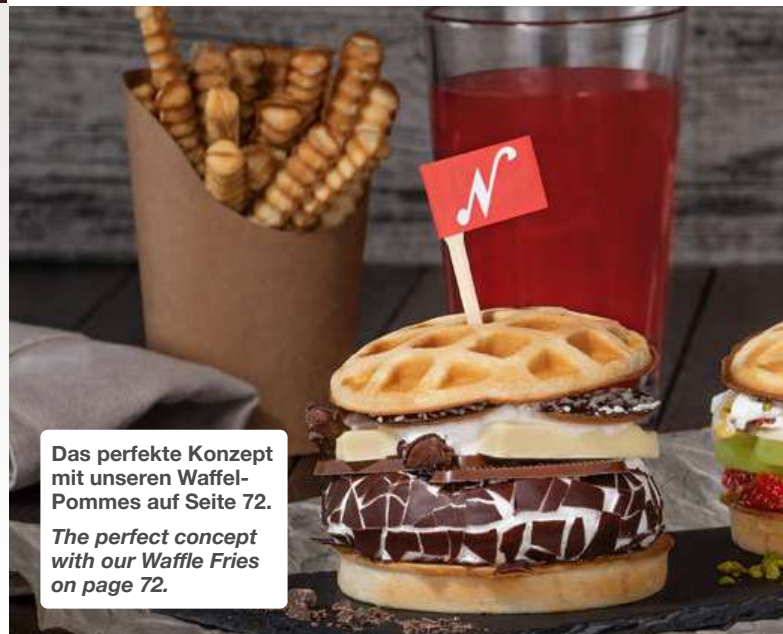

Das perfekte Konzept mit unseren Waffel-Pommes auf Seite 72.

The perfect concept with our Waffle Fries on page 72.

Teig-Auffangwanne

Batter Overflow Tub

Hält Ihren Thermocook auch beim versehentlichen Überfüllen sauber • Fängt heruntertropfenden Teig sowie Fett von besonders fettigem Teig auf • Geschirrspülgerecht
• Edelstahl mit geschweißten Kanten • Geeignet für Thermocook, Backsystem und Classic Waffeleisen • Vorder- und Rückteil im Lieferumfang enthalten

Keeps your waffle maker clean even if it is accidentally overfilled • Catches dripping batter and fat from particularly fat-containing batter • Dishwasher approved • Stainless steel with welded edges • Suitable for Thermocook, Baking System and Classic Waffle Makers • Includes front and back part

 (2x) 326 x 170 x 27 mm

 0,7 kg

 10-10064

 124,-* ▲





Wähle Deine Wechselplatten Choose your interchangeable plates

Pizza Wechselplatten Pizza Interchangeable Plates

Kompatibel mit Thermocook.
Nicht geeignet für Thermocook Twin.
Nicht geeignet für Backsystem-Adapter.

Compatible with Thermocook.
Not suitable for Thermocook Twin.
Not suitable for Baking System Adapter.



Antihaftbeschichtetes Aluminium
Non-stick coated aluminium

Ø 300 x h 35 mm

6,6 kg

31-40776-01

€ 449,-* ▲



Crêpes Wechselplatten Crepes Interchangeable Plates

Kompatibel mit Thermocook.
Nicht geeignet für Thermocook Twin.
Adapter für Backsystem auf Seite 26.

Compatible with Thermocook.
Not suitable for Thermocook Twin.
Adapter for Baking System on page 26.



Antihaftbeschichtetes Aluminium
Non-stick coated aluminium

Ø 300 mm

5,5 kg

31-40774-01

€ 299,-* ▲



Basisgerät Base unit



Thermocook

Details: □ 20-26

230 V / 2,8 kW

9,5 kg

12-40801DT

€ 699,-*



Dein Thermocook
Your Thermocook

Waffeleisen mit verschraubter Backplatte // Waffle makers with fixed plates

Classic Crêpes Maker Classic Crêpes Maker

Einzelgerät Single unit 230V/2,2kW 310x340x250 mm 18kg # 12-40729DT 998,-*





Pizza

Exklusiv für den Thermocook. Die Pizza-Backplatte verwandelt Ihren Thermocook in einen vollwertigen, kleinen Pizzaofen. In dem geschlossenen Garraum lassen sich natürlich auch Flammkuchen, Foccacia oder belegte Baguettes aufbacken.

Exclusively for the Thermocook. The pizza baking plate transforms your Thermocook into a full-fledged small pizza oven. Of course the closed cooking chamber is also suitable to bake tarte flambee, foccacia, buns and bagels.

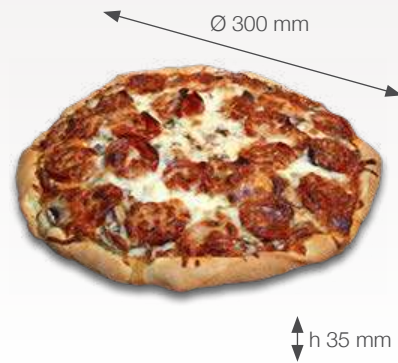

Crêpes

Französische Crêpes ganz einfach und dabei gleichmäßig in Größe und Stärke backen. Besonders bei wechselndem Personal eine sichere Lösung für beständige Produktqualität. Mit der Wechselplatte für den Thermocook gelingen ihre Crêpes genauso wie in Frankreich. Oh, là, là!

Easy baking of French crepes with a consistent size and thickness. Especially with changing personnel a solution for steady product quality. With the interchangeable plate for the Thermocook, your crêpes will turn out just like in France. Oh, là, là!

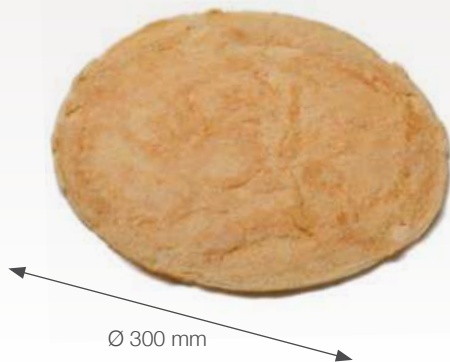

Empfohlenes Zubehör // Related accessories:

Crêpeswender | Crepes Turner

Buchenholz • Ideal für die Anwendung auf antihafbeschichteten Oberflächen • Klingenslänge 350 mm

Beech wood • Ideal for use on non-stick coated surfaces • Blade length 350 mm

05-90038 € 19,90* ▲



Trennspray Anti-adherent Spray

Details: ☐ 93

00-90101-01

€ 7,29* ▲



Crêpes-Ready-Mix Backmischung / Baking Mix

Details: ☐ 81

05-20136-01

€ 79,-* ▲





Wähle Deine Wechselplatten Choose your interchangeable plates

Panini Grill Wechselplatten Panini Grill Interchangeable Plates

Kompatibel mit Thermocook.
Nicht geeignet für Backsystem-Adapter.

Compatible with Thermocook.
Not suitable for Baking System Adapter.

Antihafbeschichtetes Aluminium
Non-stick coated aluminium

280 x 280 mm

5,3 kg

31-40775-01

€ 299,-* ▲



Sandwich Wechselplatten Sandwich Interchangeable Plates

Kompatibel mit Thermocook.
Adapter für Backsystem auf Seite 26.

Compatible with Thermocook.
Adapter for Baking System on page 26.

Antihafbeschichtetes Aluminium
Non-stick coated aluminium

(4x) 115 x 125 x 25 mm

6 kg

31-40744-01

€ 299,-* ▲



Wähle Dein Basisgerät Choose your base unit



Details: 20-26



	Power	Weight	Model #	Price
Thermocook	230V/2,8kW	9,5 kg	12-40801DT	699,-*
Thermocook Twin	400V/5,6kW	17,9 kg	12-40802DT	1448,-*
Thermocook Twin	2x 230V/2x 2,8kW	18,2 kg	12-40802DT-D	1448,-*



Dein Thermocook
Your Thermocook

Waffeleisen mit verschraubter Backplatte // Waffle makers with fixed plates

Classic Sandwich Maker Classic Sandwich Maker

	Power	Dimensions	Weight	Model #	Price
Einzelgerät Single unit	230V/2,2kW	310x340x250 mm	14 kg	12-40718DT	998,-*
Doppelgerät Double unit	400V/4,4kW	610x340x250 mm	28 kg *	12-40748DT	2046,-*



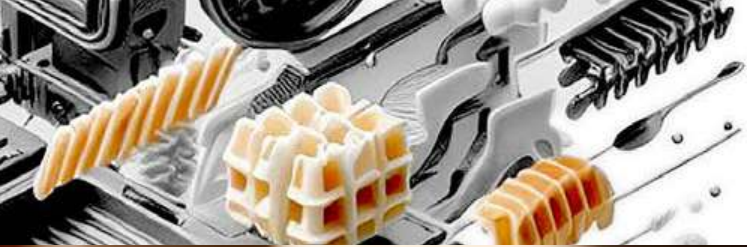

Panini Grill

Exklusiv für den Thermocook. Mit der Panini-Grillplatte machen Sie Ihren Thermocook zum ausgewachsenen Kontaktgrill. Für Paninis, Brötchen, Toast, Fladenbrot, u.v.m. Ideal, um belegte Brötchen und Paninis vor dem Servieren kurz knusprig zu erhitzen.

Exclusively for the Thermocook. The panini grill plate turns your Thermocook into a full-blown contact grill. For bread rolls, toasts, flatbread and much more. Perfect for briefly crisping up sandwiches and paninis before serving.

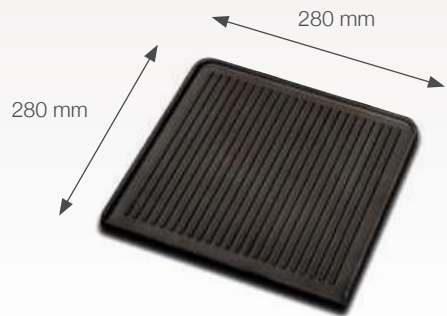

Sandwich

Der professionelle Sandwich Maker für gefüllte Sandwich Toasts. Die massiven Backplatten sorgen für Wärmespeicherung und gleichmäßige Hitzeverteilung, damit Ihre Toasts immer perfekt werden.

The professional sandwich maker for filled sandwich toasts. The massive baking plates keep always their temperature for quick cooking times.

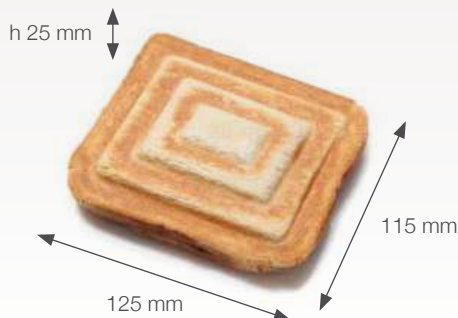

Empfohlenes Zubehör // Related accessories:

Waffelzange Waffle Tongs

Details: □□ 59

00-90097

€ 8,90* ▲



Trennspray Anti-adherent Spray

Details: □□ 93

00-90101-01

€ 7,29* ▲



Reinigungsbürste Cleaning Brush

Details: □□ 57

00-90053

€ 24,90* ▲





Wähle Deine Wechsellplatten Choose your interchangeable plates

Mexican Snack Wechsellplatten Mexican Snack Interchangeable Plates

Kompatibel mit Thermocook.
Adapter für Backsystem auf Seite 26.
*Compatible with Thermocook.
Adapter for Baking System on page 26.*

- (1x) 220 x 220 x 10 mm
- Antihafbeschichtetes Aluminium
Non-stick coated aluminium
- 4 kg
- 31-40745-01
- 299,-* ▲



Waffelschale Wechsellplatten Waffle Bowl Interchangeable Plates

Kompatibel mit Thermocook.
Adapter für Backsystem auf Seite 26.
*Compatible with Thermocook.
Adapter for Baking System on page 26.*

- (3x) 75 x 165 x 40 mm
- Antihafbeschichtetes Aluminium
Non-stick coated aluminium
- 7,5 kg
- 31-40765-01
- 299,-* ▲



Wähle Dein Basisgerät Choose your base unit



Details:				
Thermocook	230V/2,8kW	9,5 kg	12-40801DT	699,-*
Thermocook Twin	400V/5,6kW	17,9 kg	12-40802DT	1448,-*
Thermocook Twin	2x 230V/2x 2,8kW	18,2 kg	12-40802DT-D	1448,-*



Dein Thermocook
Your Thermocook

Waffeleisen mit verschraubter Backplatte // Waffle makers with fixed plates

Classic Waffeleisen Mexican Snack Classic Waffle Maker Mexican Snack

Einzelgerät	Single unit	230V/2,2kW	310x340x250 mm	12 kg	12-40717DT	998,-*
Doppelgerät	Double unit	400V/4,4kW	610x340x250 mm	23 kg *	12-40747DT	2046,-*



Classic Waffeleisen Waffelschale Classic Waffle Maker Waffle Bowls

Einzelgerät	Single unit	230V/2,2kW	310x340x250 mm	13 kg	12-40722DT	998,-*
Doppelgerät	Double unit	400V/4,4kW	610x340x250 mm	30 kg *	12-40752DT	2046,-*





Mexican Snack

Entdecken Sie die neuen Mexican Snack Wechselplatten für köstliche Quesadillas oder spanische Tortillas. Die massiven Backplatten garantieren optimale Wärmespeicherung und gleichmäßige Hitzeverteilung, um sicherzustellen, dass Ihre Gerichte schnell und gleichmäßig garen.

Discover the new Mexican Snack interchangeable plates for delicious quesadillas or Spanish tortillas. The solid baking plates guarantee optimal heat storage and even heat distribution to ensure that your dishes cook quickly and evenly.

**NEU
NEW**

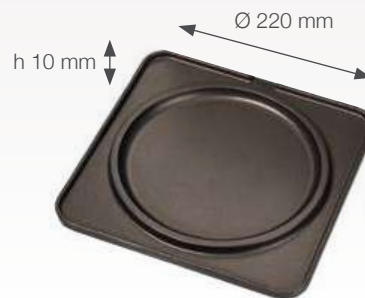

Waffelschale

Waffle Bowls

Die essbaren Snackschalen lassen sich kreativ befüllen. Mit einem Waffelteig gebacken verführerisch mit Eiscreme oder Obstsalat. Wenn die Snackschalen mit einem herzhaften Teig zubereitet werden auch ideal für Pilze, Gemüse, Salate, Geschnetzeltes, Antipasti...

The eatable snack bowls can be filled creatively. Baked with a waffle batter, they can be filled with ice cream or fruit salad. If the snack bowls are prepared with a savoury dough, they are also ideal for mushrooms, vegetables, salads, sliced meat, antipasti...



Empfohlenes Zubehör // Related accessories

Reinigungsbürste Cleaning Brush

Details: □ 57

00-90053

€ 24,90* ▲



Waffelrost Waffle Grid

Details: □ 59

10-10060

€ 93,-* ▲



Waffelzange Waffle Tongs

Details: □ 59

00-90097

€ 8,90* ▲





Wähle Deine Wechsellplatten Choose your interchangeable plates

Brüsseler Waffel Wechsellplatten Brussels Waffle Plates

Kompatibel mit Thermocook.
Adapter für Backsystem auf Seite 26.
*Compatible with Thermocook.
Adapter for Baking System on page 26.*

- Unbeschichtetes Gusseisen
Cast iron without coating
- (2x) 165 x 105 x 30 mm
- 13 kg
- 32-40715-01
- 299,-* ▲



Lorraine Waffel Wechsellplatten Lorraine Waffle Interchangeable Plates

Kompatibel mit Thermocook.
Adapter für Backsystem auf Seite 26.
*Compatible with Thermocook.
Adapter for Baking System on page 26.*

- (2x) 150 x 105 x 32 mm
- Unbeschichtetes Gusseisen
Cast iron without coating
- 15 kg
- 32-40742-01
- 299,-* ▲



Wähle Dein Basisgerät Choose your base unit



Details:				
Thermocook	230V/2,8kW	9,5 kg	12-40801DT	699,-*
Thermocook Twin	400V/5,6kW	17,9 kg	12-40802DT	1448,-*
Thermocook Twin	2x 230V/2x 2,8kW	18,2 kg	12-40802DT-D	1448,-*



Dein Thermocook
Your Thermocook

Waffeleisen mit verschraubter Backplatte // Waffle makers with fixed plates

Classic Waffeleisen Brüsseler Waffel Classic Waffle Maker Big Hearts Waffle

Einzelgerät	Single unit	230V/2,2kW	310x340x250 mm	22 kg	12-40715DT	998,-*
Doppelgerät	Double unit	400V/4,4kW	610x340x250 mm	44 kg *	12-40745DT	2046,-*



Classic Waffeleisen Lorraine Classic Waffle Maker Lorraine

Einzelgerät	Single unit	230V/2,2kW	310x340x250 mm	19 kg	12-40712DT	998,-*
Doppelgerät	Double unit	400V/4,4kW	610x340x250 mm	31 kg *	12-40742DT	2046,-*



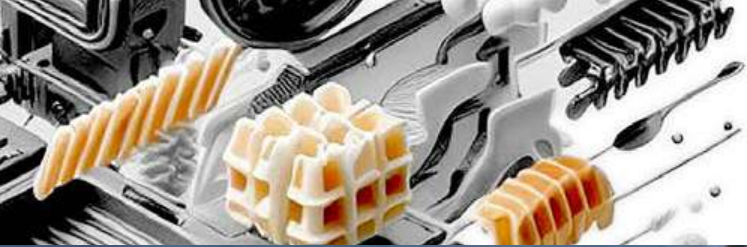

Brüsseler Waffel

Brussels Waffle

Die traditionelle Waffel der Benelux-Region: Der Klassiker. Mit 30 mm Stärke ist diese Waffel eine wirklich sättigende Portion, die aufgrund der Größe auch hochpreisig verkauft werden kann. In Deutschland wird sie meist mit heißen Kirschen und Sahne serviert.

The traditional waffle of the Benelux region: The classic. With 30 mm thickness this waffle is a really filling portion. Due to the size it can be offered for a high price. In Germany it is common to serve it with cherry sauce and whipped cream.

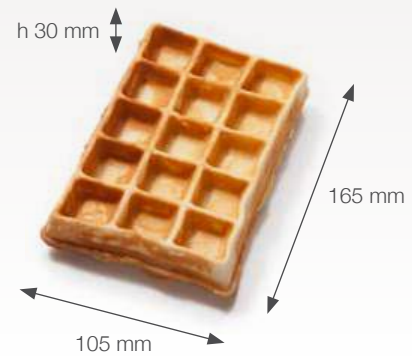

Lorraine Waffel

Lorraine Waffle

Die kompakte Variante der klassischen eckigen Waffel.
The compact variation of the classic square waffle.

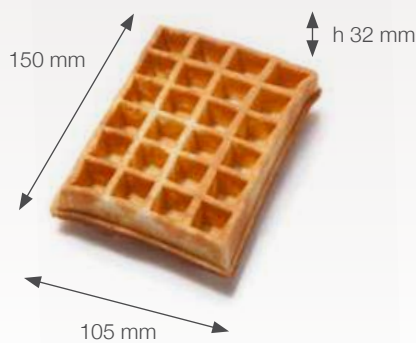

Empfohlenes Zubehör // Related accessories

Waffelgabel Waffle Fork

Details: □ 59

06-90015

€ 37,-* ▲



Teigportionierer Batter Dispenser

Details: □ 61

05-40251N

€ 1153,-* ▲



Waffel-Ready-Mix Backmischung / Baking Mix

Details: □ 65

05-20122-01

€ 88,-* ▲





Wähle Deine Wechsellplatten Choose your interchangeable plates

Kant-Waffel Wechsellplatten Kant Waffle Interchangeable Plates

Kompatibel mit Thermocook.
Adapter für Backsystem auf Seite 26.
Compatible with Thermocook.
Adapter for Baking System on page 26.

- (2x) 153 x 80 x 19 mm
- Unbeschichtetes Gusseisen
Cast iron without coating
- 10,5 kg
- # 32-40725-01
- € 299,-* ▲



Americano Waffel Wechsellplatten Americano Waffle Interchangeable Plates

Kompatibel mit Thermocook.
Adapter für Backsystem auf Seite 26.
Compatible with Thermocook.
Adapter for Baking System on page 26.

- (1x) 185 x 185 x 30 mm
- Antihafbeschichtetes Aluminium
Non-stick coated aluminium
- 5 kg
- # 31-40733-01
- € 299,-* ▲



Wähle Dein Basisgerät Choose your base unit



Details:				
Thermocook	230V/2,8kW	9,5 kg	12-40801DT	699,-*
Thermocook Twin	400V/5,6kW	17,9 kg	12-40802DT	1448,-*
Thermocook Twin	2x 230V/2x 2,8kW	18,2 kg	12-40802DT-D	1448,-*



Dein Thermocook
Your Thermocook

Waffeleisen mit verschraubter Backplatte // Waffle makers with fixed plates

Classic Waffeleisen Kant Classic Waffle Maker Kant

Einzelgerät	Single unit	230V/2,2kW	310x340x250 mm	16 kg	12-40714DT	998,-*
Doppelgerät	Double unit	400V/4,4kW	610x340x250 mm	36 kg *	12-40744DT	2046,-*



Classic Waffeleisen Americano Classic Waffle Maker Americano

Einzelgerät	Single unit	230V/2,2kW	310x340x250 mm	13 kg	12-40721DT	998,-*
Doppelgerät	Double unit	400V/4,4kW	610x340x250 mm	34 kg *	12-40751DT	2046,-*



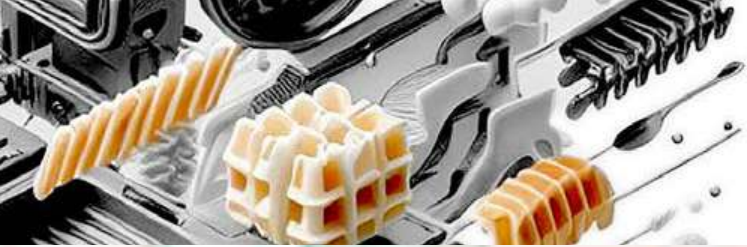

Kant-Waffel

Kant Waffle

Optisch an die Brüsseler Waffel angelehnt, aber etwas kleiner und dünner. Hier werden häufig beide Waffeln eines Backvorgangs gemeinsam serviert.

Similar to the Brussels Waffle, but smaller and thinner. Often both waffles of one baking progress are served together.

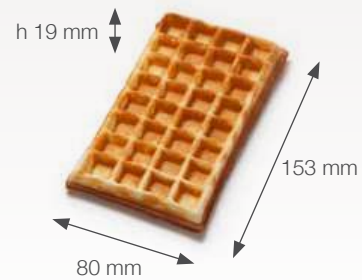

Americano Waffel

Americano Waffle

Die amerikanische Frühstückswaffel wird typischerweise mit Bacon und Ahornsirup serviert und ist aufgrund der Größe eine vollwertige Mahlzeit.

The American breakfast waffle is typically topped with bacon and maple syrup. This is a full meal size waffle.

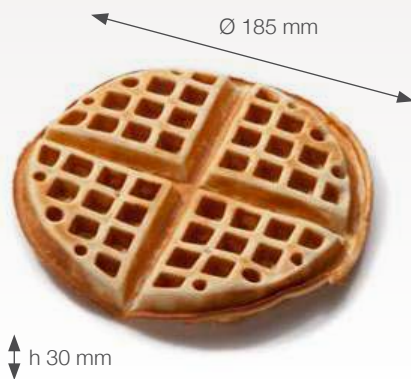

Empfohlenes Zubehör // Related accessories

Waffelrost Waffle Grid

Details: □□ 59

10-10060

€ 93,-* ▲



Trennspray Anti-Adherent Spray

Details: □□ 60

00-90102-01

€ 7,89* ▲



Waffel-Ready-Mix Backmischung / Baking Mix

Details: □□ 65

05-20122-01

€ 88,-* ▲





Wähle Deine Wechsellplatten Choose your interchangeable plates

Große Herzwaffel Wechsellplatten Big Hearts Waffle Interchangeable Plates

Kompatibel mit Thermocook.
Adapter für Backsystem auf Seite 26.
*Compatible with Thermocook.
Adapter for Baking System on page 26.*

(1x) 210 x 210 x 13 mm

Unbeschichtetes Gusseisen
Cast iron without coating

10 kg

32-40720-01

299,-* ▲



Kleine Herzwaffel Wechsellplatten Small Hearts Interchangeable Plates

Kompatibel mit Thermocook.
Adapter für Backsystem auf Seite 26.
*Compatible with Thermocook.
Adapter for Baking System on page 26.*

(1x) 155 x 155 x 13 mm

Unbeschichtetes Gusseisen
Cast iron without coating

8 kg

32-40747-01

299,-* ▲



Wähle Dein Basisgerät Choose your base unit



Details:				
Thermocook	230V/2,8kW	9,5 kg	12-40801DT	699,-*
Thermocook Twin	400V/5,6kW	17,9 kg	12-40802DT	1448,-*
Thermocook Twin	2x 230V/2x 2,8kW	18,2 kg	12-40802DT-D	1448,-*



**Dein Thermocook
Your Thermocook**

Waffeleisen mit verschraubter Backplatte // Waffle makers with fixed plates

Classic Waffeleisen Große Herzwaffel Classic Waffle Maker Big Hearts Waffle

Einzelgerät	Single unit	230V/2,2kW	310x340x250 mm	18,5kg	12-40720DT	998,-*
Doppelgerät	Double unit	400V/4,4kW	610x340x250 mm	36kg *	12-40750DT	2046,-*



Classic Waffeleisen Kleine Herzwaffel Classic Waffle Maker Small Hearts Waffle

Einzelgerät	Single unit	230V/2,2kW	310x340x250 mm	14kg	12-40719DT	998,-*
Doppelgerät	Double unit	400V/4,4kW	610x340x250 mm	33kg *	12-40749DT	2046,-*



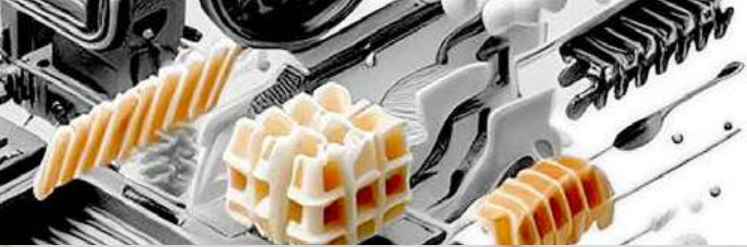

Große Herzwaffel

Big Heart Waffle

Die Bergische Waffel, auch als Herzwaffel bekannt, ist in Deutschland die wohl traditionellste Form. Einer der erfolgreichsten Waffeltrends zurzeit ist es, diese klassische Waffel zusammenzuklappen und üppig mit Zutaten nach Kundenwunsch zu füllen.

The Bergisch Waffle, also known as Hearts Waffle, is Germany's most popular shape. A current trend is to fold this classic waffle and to fill it with ingredients according to the customers' desire.

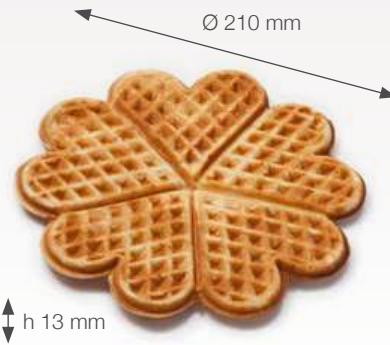

Kleine Herzwaffel

Small Heart Waffle

Eine kleinere Version der beliebten Herzwaffel. Die kompakte Form eignet sich ideal als leichte Waffel für Zwischendurch oder als Begleitung zum nachmittäglichen Kaffee.

A smaller version of the popular hearts waffle. The compact shape is ideal as a light waffle for a snack or as an accompaniment for an afternoon coffee.

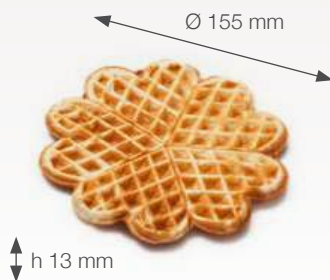

Empfohlenes Zubehör // Related accessories

Auffangschale Overflow Tub

Details: □ 27

10-10064

€ 124,-* ▲

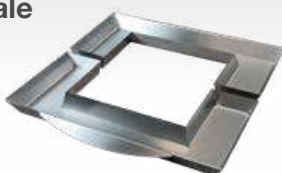

Waffelzange Waffle Tongs

Details: □ 59

00-90097

€ 8,90* ▲



Trennspray Anti-Adherent Spray

Details: □ 60

00-90102-01

€ 7,89* ▲





Wähle Deine Wechsellplatten Choose your interchangeable plates

Pancakes Wechsellplatten Pancakes Interchangeable Plates

Kompatibel mit Thermocook.
Adapter für Backsystem auf Seite 26.
*Compatible with Thermocook.
Adapter for Baking System on page 26.*

(5x) 95 x 95 x 11 mm

Antihafbeschichtetes Aluminium
Non-stick coated aluminium

4 kg

31-40748-01

299,-* ▲



Sunny Waffel Wechsellplatten Sunny Waffle Interchangeable Plates

Kompatibel mit Thermocook.
Adapter für Backsystem auf Seite 26.
*Compatible with Thermocook.
Adapter for Baking System on page 26.*

(1x) 195 x 195 x 20 mm

Antihafbeschichtetes Aluminium
Non-stick coated aluminium

5 kg

31-40758-01

299,-* ▲



Wähle Dein Basisgerät Choose your base unit



Details:				
Thermocook	230V/2,8kW	9,5 kg	12-40801DT	699,-*
Thermocook Twin	400V/5,6kW	17,9 kg	12-40802DT	1448,-*
Thermocook Twin	2x 230V/2x 2,8kW	18,2 kg	12-40802DT-D	1448,-*



**Dein Thermocook
Your Thermocook**

Waffeleisen mit verschraubter Backplatte // Waffle makers with fixed plates

Classic Pancake Maker Classic Pancake Maker

Einzelgerät	Single unit	230V/2,2kW	310x340x250 mm	20 kg	12-40739DT	998,-*
Doppelgerät	Double unit	400V/4,4kW	610x340x250 mm	36 kg *	12-40759DT	2046,-*



Classic Waffeleisen Sunny Classic Waffle Maker Sunny

Einzelgerät	Single unit	230V/2,2kW	310x340x250 mm	13 kg	12-40732DT	998,-*
Doppelgerät	Double unit	400V/4,4kW	610x340x250 mm	31 kg *	12-40763DT	2046,-*





Pancakes

Goldene, luftig-leichte Pancakes können mit einer Vielzahl an köstlichen Toppings serviert werden. Ein Gastronomie-Konzept für Hotels, Cafés oder für den Straßenverkauf. Pancakes sind ideal als Frühstück am Hotel-Buffer, zum Brunch, Nachmittags zum Kaffee oder als herzhafter Snack.

Golden, light and fluffy pancakes can be served with a variety of delicious toppings. A catering concept for hotels, cafés or street vendors. Pancakes are ideal for hotel buffets, breakfast, brunch, afternoon coffee or as a savoury snack.

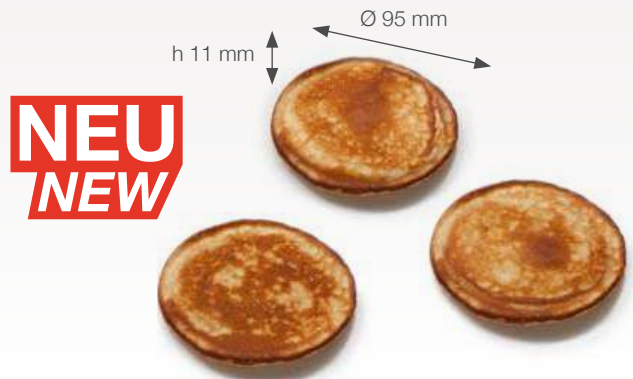

Sunny Waffel

Sunny Waffle

Die Sunny Waffel ist eine Neuerung der traditionellen Bergischen Waffel, auch als Herzwaffel bekannt. Die moderne Form mit 4 Teilstücken hat besonders formschöne Herzen und durch das feine quadratische Muster gelingt sie knuspriger, als das klassische Vorbild. Die Sunny Waffel hat eine einzigartige Form, bewahrt dabei aber die Ästhetik der traditionellen, deutschen Herzwaffeln.

The Sunny Waffle is a reinvention of the traditional Bergische Waffle, also known as the heart waffle. The modern shape with 4 sections has beautifully shaped hearts and the fine square pattern makes it crispier than the classic model. The Sunny Waffle has a unique shape, but retains the aesthetics of the traditional German heart waffle.

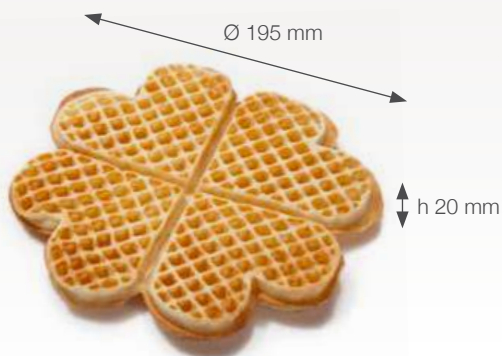

Empfohlenes Zubehör // Related accessories

Reinigungsbürste Cleaning Brush

Details: □□ 57

00-90054

€ 9,90* ▲



Pudersuckersieb Powder Sugar Sieve

Details: □□ 59

05-90290

€ 46,-* ▲



Waffelzange Waffle Tong

Details: □□ 59

00-90097

€ 8,90* ▲





Wähle Deine Wechsellatten Choose your interchangeable plates

Lolly-Waffel Wechsellatten (Gusseisen) Lolly Waffle Interchangeable Plates (cast iron)

Kompatibel mit Thermocook.
Nicht geeignet für Thermocook Twin.
Adapter für Backsystem auf Seite 26.

Compatible with Thermocook.
Not suitable for Thermocook Twin.
Adapter for Baking System on page 26.

(4x) 60 x 25 x 230 mm

Unbeschichtetes Gusseisen
Cast iron without coating

15 kg

32-40769-01

299,-* ▲



Lolly-Waffel Wechsellatten (Aluminium) Lolly Waffle Interchangeable Plates (aluminium)

Kompatibel mit Thermocook.
Nicht geeignet für Thermocook Twin.
Adapter für Backsystem auf Seite 26.

Compatible with Thermocook.
Not suitable for Thermocook Twin.
Adapter for Baking System on page 26.

(4x) 60 x 25 x 230 mm

Antihafbeschichtetes Aluminium
Non-stick coated aluminium

6,5 kg

31-40759-01

299,-* ▲



Waffel-Bärchen am Stiel Wechsellatten Waffle Bears on a Stick Interchangeable Plates

Kompatibel mit Thermocook.
Nicht geeignet für Thermocook Twin.
Adapter für Backsystem auf Seite 26.

Compatible with Thermocook.
Not suitable for Thermocook Twin.
Adapter for Baking System on page 26.

(4x) 120 x 120 x 18 mm

Antihafbeschichtetes Aluminium
Non-stick coated aluminium

4 kg

31-40731-01

299,-* ▲



Basisgerät Base unit



Thermocook

Details: 20-26

230 V / 2,8 kW

9,5 kg

12-40801DT

699,-*

Waffeleisen mit verschraubter Backplatte // Waffle makers with fixed plates

Classic Waffeleisen Lolly Classic Waffle Maker Lolly

Gusseisen, Einzelg.	Cast Iron, Single unit	230V/2,2kW	310x340x250 mm	26kg	12-40738DT	998,-*
Aluminium, Einzelg.	Aluminium, Single u.	230V/2,2kW	310x340x250 mm	14kg	12-40734DT	998,-*

Classic Waffeleisen Bärchen am Stiel Classic Waffle Maker Bears on a Stick

Einzelgerät	Single unit	230V/2,2kW	310x340x250 mm	12kg	12-40731DT	998,-*



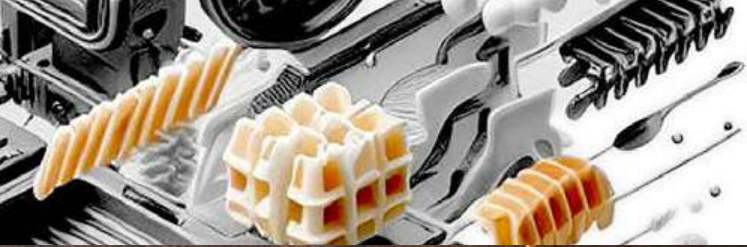

Lolly-Waffel

Lolly Wäffle

Die Event-Waffel. Extrem kurze Backzeit von ca. 1 Minute für 4 Waffeln, wenig Teigeinsatz, auffällig in der Größe, kreativ als Tannenbaum- oder Schwert-Waffel zu vermarkten.

The Event Waffle. Extremely short baking time of approx. 1 minute for 4 waffles, little cost of goods and striking design. Offers creative marketing possibilities like a christmas tree or a sword waffle.

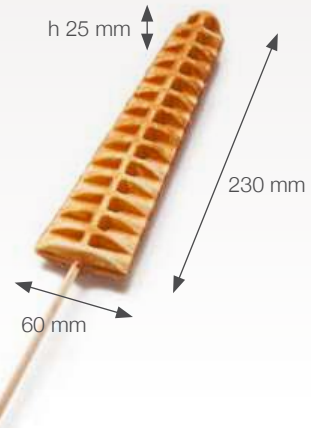

Waffel-Bärchen am Stiel

Waffle Bears on a Stick

Die runden Teddygesichter lassen sich großartig dekorieren und benötigen nur kurze Backzeiten. Ideal für Kinderfeste.

The round teddy faces are great to decorate and need only a short baking time. Ideally for childrens festivals.

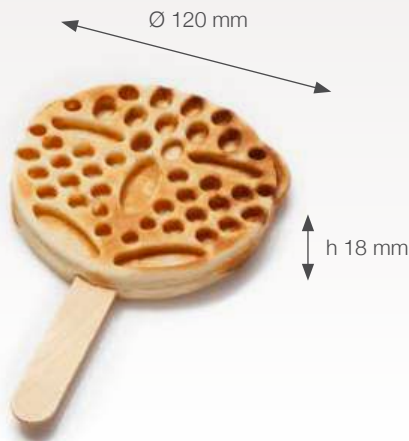

Empfohlenes Zubehör // Related accessories

Tischständer

Table Stand

Edelstahl • Für 8 Waffeln
Stainless steel • For 8 waffles

10-40003 € 114,-* ▲



Lolly-Waffelstiele 380 mm

Lolly Waffle Sticks 380 mm

🛒	#	€
1200 x	01-51556	49,-* ▲
4800 x	01-51554	169,-* ▲



Waffel-Ready-Mix

Backmischung / Baking Mix

Details: ☐ 65

05-20122-01

€ 88,-* ▲





Wähle Deine Wechsellplatten Choose your interchangeable plates

Waffel-Herz am Stiel Wechsellplatten Waffle Heart on a Stick Interchangeable Plates

Kompatibel mit Thermocook.
Nicht geeignet für Thermocook Twin.
Adapter für Backsystem auf Seite 26.

Compatible with Thermocook.
Not suitable for Thermocook Twin.
Adapter for Baking System on page 26.

(4x) 135 x 130 x 32 mm

Unbeschichtetes Gusseisen
Cast iron without coating

16 kg

32-40744-01

€ 299,-* ▲



Rahwaffel am Stiel Wechsellplatten Cream Waffle on a Stick Interchangeable Plates

Kompatibel mit Thermocook.
Nicht geeignet für Thermocook Twin.
Adapter für Backsystem auf Seite 26.

Compatible with Thermocook.
Not suitable for Thermocook Twin.
Adapter for Baking System on page 26.

(6x) 65 x 100 x 30 mm

Unbeschichtetes Gusseisen
Cast iron without coating

14 kg

32-40743-01

€ 299,-* ▲



+ Basisgerät Base unit



Thermocook

Details: 20-26

230 V / 2,8 kW

9,5 kg

12-40801DT

€ 699,-*



Dein Thermocook Your Thermocook



Waffeleisen mit verschraubter Backplatte // Waffle makers with fixed plates

Classic Waffeleisen Herz am Stiel Classic Waffle Maker Heart on a Stick

Einzelgerät Single unit 230V/2,2kW 310x340x250 mm 24 kg # 12-40711DT € 998,-*

Classic Waffeleisen Rahmwaffel am Stiel Classic Waffle Maker Cream Waffle on a Stick

Einzelgerät Single unit 230V/2,2kW 310x340x250 mm 21 kg # 12-40713DT € 998,-*



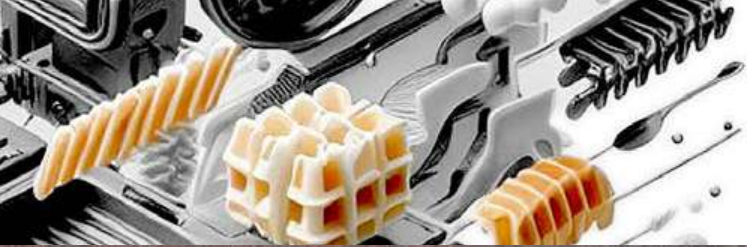

Waffel-Herz am Stiel

Waffle Heart on a Stick

Knabber-Herzen am Stiel, perfekt zum Valentinstag. Die größte Waffel am Stiel passt super zu Themenevents und Catering.

Tasty hearts on a stick, especially great for Valentine's Day. The biggest waffle on a stick fits perfectly to themed events and parties.

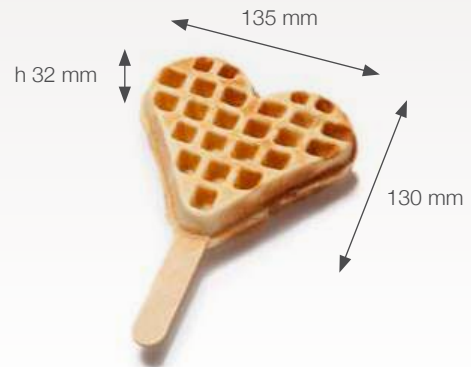

Rahmwaffel am Stiel

Cream Waffle on a Stick

Kleine Waffeln am Stiel in der traditionellen, eckigen Waffelform. Ideale Portionsgröße für Kinder oder den kleinen Heißhunger.

Small waffles on a stick with the traditional square waffle shape. An ideal portion size for children or as a little snack in case of a ravenous appetite.



Empfohlenes Zubehör // Related accessories

Holzstiele 1000 Stk. | Wooden Sticks 1000 pcs

150 x 18 mm • Birke • Für Rahmwaffel, Waffel-Bärchen und Waffel-Herz am Stiel

150 x 18 mm • Birch wood • For Cream Waffle, Waffle Bear and Waffle Heart on a Stick

10-90093N 1000x € 69,90* ▲



Tischständer | Table Stand

Für Rahmwaffel, Waffel-Bärchen und Waffel-Herz am Stiel • Edelstahl • für 11 Waffeln

For Cream Waffle, Waffle Bear and Waffle Heart on a Stick • Stainless steel • For 11 waffles

10-40000 € 114,-* ▲

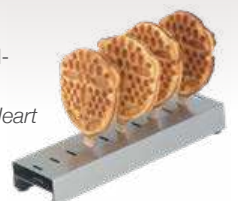



▶ Wähle Deine Wechsellplatten Choose your interchangeable plates

Waffel-Taler Wechsellplatten Waffle Coins Interchangeable Plates

Kompatibel mit Thermocook.
Adapter für Backsystem auf Seite 26.
*Compatible with Thermocook.
Adapter for Baking System on page 26.*

(6x) 80 x 80 x 16 mm

Unbeschichtetes Gusseisen
Cast iron without coating

12,5 kg

32-40732-01

299,-* ▲



Churros Wechsellplatten Churros Interchangeable Plates

Kompatibel mit Thermocook.
Adapter für Backsystem auf Seite 26.
*Compatible with Thermocook.
Adapter for Baking System on page 26.*

(10x) 210 x 20 x 14 mm

Unbeschichtetes Gusseisen
Cast iron without coating

15 kg

32-40772-01

299,-* ▲



+ Wähle Dein Basisgerät Choose your base unit



Details:				
Thermocook	230V/2,8kW	9,5 kg	12-40801DT	699,-*
Thermocook Twin	400V/5,6kW	17,9 kg	12-40802DT	1448,-*
Thermocook Twin	2x 230V/2x 2,8kW	18,2 kg	12-40802DT-D	1448,-*



**Dein Thermocook
Your Thermocook**

Waffeleisen mit verschraubter Backplatte // Waffle makers with fixed plates

Classic Waffeleisen Waffel-Taler Classic Waffle Maker Waffle Coins

Einzelgerät	Single unit	230V/2,2kW	310x340x250 mm	20 kg	12-40716DT	998,-*
Doppelgerät	Double unit	400V/4,4kW	610x340x250 mm	36 kg *	12-40746DT	2046,-*



Classic Waffeleisen Churros Classic Waffle Maker Churros

Einzelgerät	Single unit	230V/2,2kW	310x340x250 mm	16 kg	12-40728DT	998,-*
Doppelgerät	Double unit	400V/4,4kW	610x340x250 mm	33 kg *	12-40758DT	2046,-*





Waffel-Taler

Waffle Coins

Kleine, handliche Taler zum Snacken. Ideal, um unterschiedliche Portionsgrößen anzubieten.

Little waffle coins for snacking. Ideally suitable to offer different portion sizes.

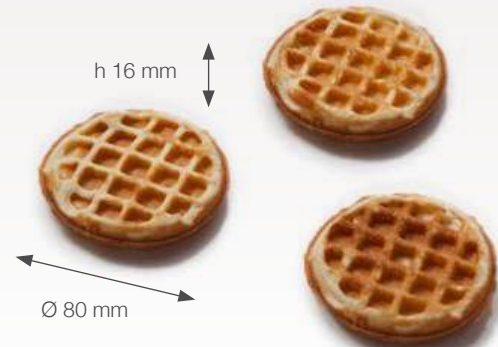

Churros

Der beliebte Snack zum Dippen aus Spanien als fettarmes Backprodukt. Wir empfehlen die Kombination mit dickflüssiger Trinkschokolade. Wird mit einem Waffelteig gebacken. Nicht mit dem originalen Churros Ready Mix zu verwenden.

The popular Spanish snack for dipping now as a lower-fat baking product. We recommend the combination with a thick hot chocolate drink. Has to be baked with a waffle batter. Not to be used with the original Churros Ready Mix.



Empfohlenes Zubehör // Related accessories

Waffelrost Waffle Grid

Details: □□ 59

10-10060

€ 93,-* ▲



Waffelzange Waffle Tongs

Details: □□ 59

00-90097

€ 8,90* ▲



Trennspray Anti-Adherent Spray

Details: □□ 60

00-90102-01

€ 7,89* ▲





Wähle Deine Wechsellplatten Choose your interchangeable plates

Waffelbällchen Wechsellplatten Waffle Balls Interchangeable Plates

Kompatibel mit Thermocook.
Adapter für Backsystem auf Seite 26.
Compatible with Thermocook.
Adapter for Baking System on page 26.

(25x) 40 x 40 x 25 mm

Antihafbeschichtetes Aluminium
Non-stick coated aluminium

6 kg

31-40760-01

299,-* ▲



Dony Donut Wechsellplatten Dony Donut Interchangeable Plates

Kompatibel mit Thermocook.
Adapter für Backsystem auf Seite 26.
Compatible with Thermocook.
Adapter for Baking System on page 26.

(9x) 80 x 80 x 26 mm

Antihafbeschichtetes Aluminium
Non-stick coated aluminium

6 kg

31-40761-01

299,-* ▲



Wähle Dein Basisgerät Choose your base unit



Details:				
Thermocook	230V/2,8kW	9,5 kg	12-40801DT	699,-*
Thermocook Twin	400V/5,6kW	17,9 kg	12-40802DT	1448,-*
Thermocook Twin	2x 230V/2x 2,8kW	18,2 kg	12-40802DT-D	1448,-*



Dein Thermocook
Your Thermocook

Waffeleisen mit verschraubter Backplatte // Waffle makers with fixed plates

Classic Waffeleisen Waffelbällchen Classic Waffle Maker Waffle Balls

Einzelgerät	Single unit	230V/2,2kW	310x340x250 mm	20 kg	12-40724DT	998,-*
Doppelgerät	Double unit	400V/4,4kW	610x340x250 mm	36 kg *	12-40754DT	2046,-*



Classic Waffeleisen Dony Donut Classic Waffle Maker Dony Donut

Einzelgerät	Single unit	230V/2,2kW	310x340x250 mm	14 kg	12-40761DT	998,-*
Doppelgerät	Double unit	400V/4,4kW	610x340x250 mm	33 kg *	12-40762DT	2046,-*





Waffelbällchen

Waffle Balls

Miniwaffeln perfekt zum Naschen. Im Tütchen verkauft sind sie ein toller Proviant für einen Spaziergang durch die Stadt.

Tiny „Mini Waffles“ for people in favour of sweets. Filled into a little bag they are a great take-away snack while having a walk in the city.



Dony Donut

Leckere Donuts als fettarm gebackene Variante aus dem Waffeleisen.

Tasty donuts as a low-fat baked version from a waffle maker.

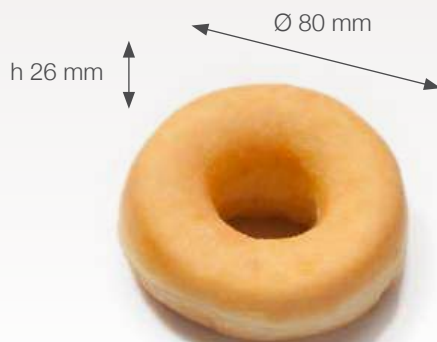

Empfohlenes Zubehör // Related accessories

Reinigungsbürste Cleaning Brush

Details: □ 57

00-90053

€ 24,90* ▲



Waffelrost Waffle Grid

Details: □ 59

10-10060

€ 93,-* ▲



Waffelzange Waffle Tongs

Details: □ 59

00-90097

€ 8,90* ▲





Wähle Deine Wechsellplatten Choose your interchangeable plates

Stroopwaffel Wechsellplatten Stroopwaffle Interchangeable Plates





Kompatibel mit Thermocook.
Adapter für Backsystem auf Seite 26.
Compatible with Thermocook.
Adapter for Baking System on page 26.

-  250 x 250 x ca. 3 mm
-  Unbeschichtetes Gusseisen
Cast iron without coating
-  9 kg
-  32-40711-01
-  299,-* ▲



X-Waffel Wechsellplatten X-Waffle Interchangeable Plates





Kompatibel mit Thermocook.
Adapter für Backsystem auf Seite 26.
Compatible with Thermocook.
Adapter for Baking System on page 26.

-  (2x) 108 x 108 x 20 mm
-  Unbeschichtetes Gusseisen
Cast iron without coating
-  15 kg
-  32-40704-01
-  299,-* ▲



Wähle Dein Basisgerät Choose your base unit









Details:	 20-26				
Thermocook	230V/2,8kW	9,5 kg	12-40801DT	699,-*	
Thermocook Twin	400V/5,6kW	17,9 kg	12-40802DT	1448,-*	
Thermocook Twin	2x 230V/2x 2,8kW	18,2 kg	12-40802DT-D	1448,-*	



Dein Thermocook
Your Thermocook







Waffeleisen mit verschraubter Backplatte // Waffle makers with fixed plates

Classic Waffeleisen Stroopwaffel Classic Waffle Maker Stroopwaffle

						
Einzelgerät	Single unit	230V/2,2kW	310x340x250 mm	16 kg	12-40733DT	998,-*
Doppelgerät	Double unit	400V/4,4kW	610x340x250 mm	31 kg *	12-40743DT	2046,-*



Classic Waffeleisen X-Waffel Classic Waffle Maker X-Waffle

						
Einzelgerät	Single unit	230V/2,2kW	310x340x250 mm	16 kg	12-40704DT	998,-*
Doppelgerät	Double unit	400V/4,4kW	610x340x250 mm	32 kg *	12-40764DT	2046,-*





Stroopwaffle

Stroopwaffle

Die holländische Spezialität mit einem Kern aus Karamellsirup. Mit der neuen, optimierten Wechselplatte für den Thermocook gelangen ihre Stroopwaffeln jetzt genauso, wie das holländischen Original! Servieren Sie die Stroopwaffle als Tassendeckel für Heißgetränke: Der Dampf bringt Waffle und Sirup auf die perfekte Temperatur!

The Dutch specialty with a caramel syrup core. With the new, optimised interchangeable plate for the Thermocook, your Stroopwaffles now turn out just like the Dutch original! Serve the waffles as a cup lid for hot beverages: The steam gives the perfect temperature to the waffle and the syrup!

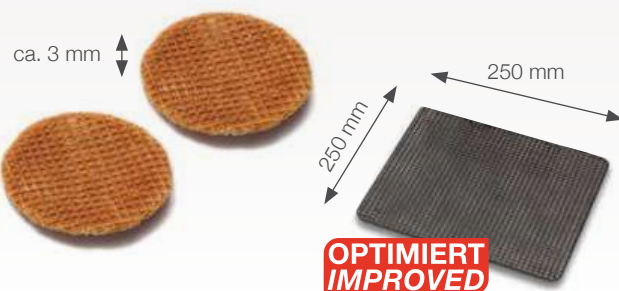

X-Waffle

X-Waffle

Das besondere Waffle Sandwich kann beliebig gefüllt werden. Perfekt für Unterwegs: Es werden weder Besteck noch ein Teller benötigt!

The unique waffle sandwich can be stuffed according to the customer. Perfectly on the go: There is no need for a plate and cutlery!

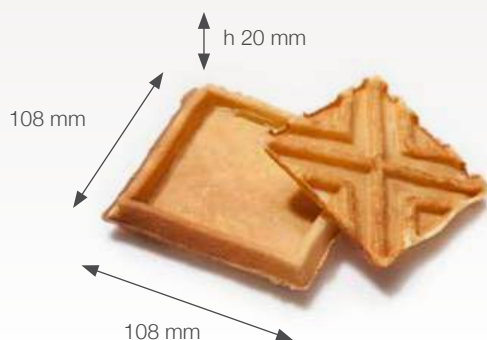

NUR SOLANGE DER VORRAT REICHT
AS LONG AS STOCK LASTS



Empfohlenes Zubehör // Related accessories

Reinigungsbürste

Cleaning Brush

Details: □ 57

00-90053

€ 24,90* ▲



Waffelrost

Waffle Grid

Details: □ 59

10-10060

€ 93,-* ▲



FIFO™ -Flasche

FIFO™ Bottle

Details: □ 60

01-40263-01

€ 11,-* ▲





Wähle Deine Wechsellplatten Choose your interchangeable plates

Eiswaffel Wechsellplatten Ice Cream Waffle Interchangeable Plates

Kompatibel mit Thermocook.
Adapter für Backsystem auf Seite 26.
Compatible with Thermocook.
Adapter for Baking System on page 26.

 260 x 260 mm

 Unbeschichtetes Gusseisen
Cast iron without coating

 11 kg

 32-40710-01

 299,-* ▲



Waffeltörtchen Wechsellplatten Waffle Tart Interchangeable Plates

Kompatibel mit Thermocook.
Adapter für Backsystem auf Seite 26.
Compatible with Thermocook.
Adapter for Baking System on page 26.

 (4x) 125 x 125 x 26 mm

 Unbeschichtetes Gusseisen
Cast iron without coating

 16,5 kg





 32-40736-01

 299,-* ▲



Wähle Dein Basisgerät Choose your base unit



Details:	 20-26				
Thermocook	230V/2,8kW	9,5 kg	12-40801DT	699,-*	
Thermocook Twin	400V/5,6kW	17,9 kg	12-40802DT	1448,-*	
Thermocook Twin	2x 230V/2x 2,8kW	18,2 kg	12-40802DT-D	1448,-*	



Dein Thermocook
Your Thermocook







Waffeleisen mit verschraubter Backplatte // Waffle makers with fixed plates

Classic Waffeleisen Eiswaffel Classic Waffle Maker Ice Cream Waffle

						
Einzelgerät	Single unit	230V/2,2kW	310x340x250 mm	16 kg	12-40710DT	998,-*
Doppelgerät	Double unit	400V/4,4kW	610x340x250 mm	31 kg *	12-40740DT	2046,-*



Classic Waffeleisen Waffeltörtchen Classic Waffle Maker Waffle Tart

						
Einzelgerät	Single unit	230V/2,2kW	310x340x250 mm	20 kg	12-40736DT	998,-*
Doppelgerät	Double unit	400V/4,4kW	610x340x250 mm	31 kg *	12-40741DT	2046,-*



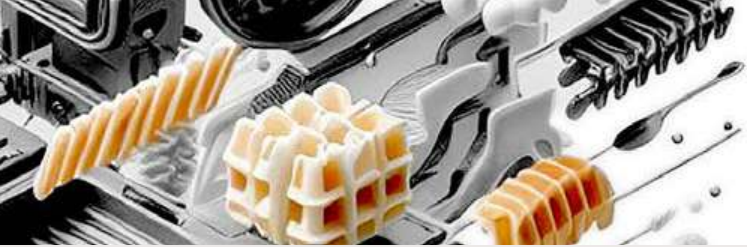

Eiswaffel

Ice Cream Waffle

Ist Ihre Eiscreme bereits hausgemacht? Dann backen Sie doch Ihre Hörnchen und Schälchen auch selbst. Ihre Kunden werden es schätzen! Durch das neue, optimierte Gussverfahren der Backplatten werden die Eiswaffeln gleichmäßig dünn und knusprig.

Do you offer home-made ice cream? Why don't you also bake the cones yourself? Your customers will appreciate it! Due to the improved casting process of the baking plates your ice waffles will be perfectly thin and crispy.



Waffeltörtchen

Waffle Tart

Grenzen Sie sich von der Konkurrenz ab! Stärken Sie das Image Ihres Eiscafés mit dekorativen, hausgemachten Eisschälchen. Oder servieren Sie im Restaurant Obstsalate und Nachspeisen in den Waffeltörtchen!

Distinguish yourself from your competitors! Increase your market aware-ness with creative home-made bowls for your ice-cream. Or you can use the Waffle Tarts to serve fruit salads and desserts in your restaurant!

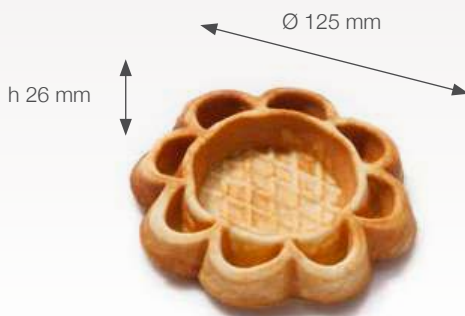

Empfohlenes Zubehör // Related accessories

Cornetti Roller Cornetti Roller

Details: □ □ 58

31-40290

€ 313,-* ▲



Körbchenpresse Basket Press

Details: □ □ 58

31-40262

€ 183,-* ▲



Hörnchenständer Cone Stand

Details: □ □ 58

10-40002

€ 85,-* ▲





Aluminium mit Antihafbeschichtung oder Gusseisen? Non-stick coated aluminium or cast iron?

	<p>Antihafbeschichtung <i>Non-stick coating</i></p>  <p>Aluminiumguss <i>Cast aluminium</i></p>	<p>Ohne Beschichtung <i>Without coating</i></p>  <p>Gusseisen <i>Cast iron</i></p>
<p>Antihafwirkung <i>Non-stick effect</i></p>	<p>★★★★★ Seltenes Fetten. <i>Rare greasing.</i></p>	<p>★★★★☆ Fettspray benötigt. <i>Fat spray needed.</i></p>
<p>Widerstandsfähigkeit <i>Durability</i></p>	<p>★★★★☆ PTFE-Antihafbeschichtung. <i>PTFE non-stick coating.</i></p>	<p>★★★★★ Unempfindliche Oberfläche aus Gusseisen. <i>Durable cast iron surface.</i></p>
<p>Tägliche Reinigung <i>Daily cleaning</i></p>	<p>★★★★★ Rückstände lösen sich besonders leicht. Nur oberflächenschonende Bürsten und Tücher. <i>Residues are easily removed. Only use surface-friendly brushes and cloths.</i></p>	<p>★★★★☆ Auch scheuernde Werkzeuge wie Metallbürsten und Scheuerschwämme möglich. <i>Also abrasive tools such as metal brushes and scouring pads.</i></p>
<p>Grundreinigung <i>Deep cleaning</i></p>	<p>★★★★☆ Back&Clean Service von Neumärker oder Sandstrahlen. Danach optional neu antihafbeschichten. <i>Sandblast and then optionally apply a new non-stick coating.</i></p>	<p>★★★★★ Back&Clean Service von Neumärker oder Sandstrahlen, Metallbürsten oder spezielle Reinigungsmittel. <i>Sandblasting, metal brushes or special cleaning agents.</i></p>
<p>Weitere Details <i>Further details</i></p>	<p>Metallwerkzeug oder Werkzeug mit harten Kanten und festen Spitzen kann die Antihafbeschichtung beschädigen. Ebenso können scheuernde oder unterwandernde Reinigungsmittel Schäden hinterlassen. Rückstände müssen mit Bürsten aus hitzebeständigem Kunststoff oder mit Naturborsten gelöst werden. Es entstehen selten festgebrannte Rückstände. Bei einer Grundreinigung wird die Antihafbeschichtung entfernt und neu aufgetragen. Eine Antihafbeschichtung gilt als Verschleißteil.</p> <p><i>Metal tools (or tools with hard edges and sharp tips) can destroy the non-stick coating. Abrasive or undermining cleaning agents can also cause damage. Residues must be removed with brushes made of heat-resistant plastic or with natural bristles. Baked-on residues rarely occur. During deep cleaning, the non-stick coating is removed and reapplied. A non-stick coating is considered a wearing part.</i></p>	<p>Äußerst widerstandsfähig, auch gegen Metallwerkzeug (Bürsten, Gabeln, etc.). Muss vor erstem Gebrauch mit Öl eingebacken werden (Dauer ca. 2 Std.). Dadurch bildet sich eine „natürliche Antihafbeschichtung“. Der Antihafeffekt verbessert sich bei pfleglichem Umgang mit der Zeit immer weiter. Geeignet für Reinigungsmittel, die Verkrustungen unterwandern und lösen. Nach einer Grundreinigung kann die „natürliche Antihafbeschichtung“ selbstständig wieder hergestellt werden kann.</p> <p><i>Extremely resistant, even to metal tools (brushes, forks, etc.). Must be seasoned with oil before first use (takes approx. 2 hours). This creates a „natural non-stick coating“. The non-stick effect improves over time if treated with care. Suitable for cleaning agents that undermine and dissolve incrustations. After deep cleaning, the „natural non-stick coating“ can be restored by the user.</i></p>

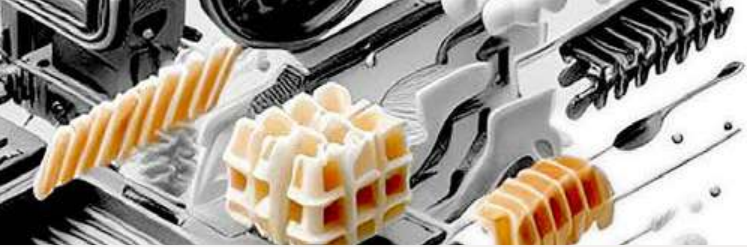

Non-Stick Coating | Antihafbeschichtung für Wechselplatten

Antihafbeschichtungs-Service für Thermocook® Wechselplatten • Rückstände der alten Antihafbeschichtung werden entfernt. Danach wird die Platte in mehreren Durchgängen mit einer neuen Antihafbeschichtung versehen und eingebrannt • Bereits vorhandene Gebrauchsspuren wie z.B. Kratzer, Risse, Kerben, Ausbrüche etc. werden nicht behoben • Nur für Wechselplatten des Neumärker Thermocook® oder Backsystem oder für bereits demontierte Backplatten. Das Einsenden von kompletten Elektrogeräten mit eingebauten Platten verursacht Mehrkosten. • Der Service umfasst die Neubeschichtung eines Wechselplattensatzes (Oberteil und Unterteil) ohne Zusatzarbeiten

44-40736

€ 59,90* S



**NEU
NEW**



Neumärker
**NON-STICK
COATING**



Ablauf der Serviceleistungen (Nur gültig innerhalb Deutschlands):

1. Sie bestellen den gewünschten Service
2. Unser Vertrieb sendet Ihnen die Auftragsbestätigung und Infos zur Rücksendung
3. Sie verpacken die Ware transportsicher und senden diese per Paketdienst an Neumärker (keine Abholung beim Kunden)
4. Wir führen den Service bei Ihren Backplatten durch
5. Rückversand: Back&Clean in ca. 14 Tagen nach Erhalt der Ware / Non-Stick Coating in ca. 3 Wochen nach Erhalt der Ware
6. Sie erhalten die Rechnung inkl. der Kosten für den Rückversand

Back & Clean | Reinigungs-Service für Gusseisenplatten

Die Gussplatte sieht nach der Reinigung wieder aus wie neu • Sämtliche Rückstände werden entfernt (z.B. Rost, eingebrannte Zuckerreste, Verkrustungen, Fettreste, Teigrückstände). Es bleibt lediglich das blanke Metall zurück! • Bereits vorhandene Gebrauchsspuren wie z.B. Kratzer, Risse, Kerben, Ausbrüche etc. werden nicht behoben • Nur für Wechselplatten des Neumärker Thermocook® oder Backsystem oder für bereits demontierte Backplatten. Das Einsenden von kompletten Elektrogeräten mit eingebauten Platten verursacht Mehrkosten. • Nur für gusseiserne Platten (Die Grundreinigung würde bei antihafbeschichteten Platten die Beschichtung entfernen. Es bleibt lediglich der blanke Metallguss zurück. Die Oberfläche wird nicht neu antihafbeschichtet.) • Der Service umfasst die Reinigung eines Wechselplattensatzes (Oberteil und Unterteil)

90-00002

€ 59,90* S



**NEU
NEW**



Neumärker
BACK & CLEAN

WAFFELZUBEHÖR



WAFFLE ACCESSORIES



Alle Thermocook® Wechsellplatten im Überblick Alle interchangeable plates for the Thermocook®

Die angegebenen Zubereitungszeiten und Temperaturen dienen als Orientierungshilfe und können je nach verwendetem Teig und persönlichem Geschmack abweichen. Bei allen Waffelbackformen gelten die Angaben für die Verwendung von Neumärker Waffle-Ready-Mix. Um Schäden zu vermeiden, reinigen und pflegen Sie die Wechsellplatten dem Material der Platte entsprechend (Seite 54).

The cooking times and temperatures given are for guidance only and may vary depending on the batter used and personal taste. For all waffle baking plates, the information applies to the use of Neumärker Waffle-Ready-Mix. To prevent damage to the interchangeable plates, clean and maintain them according to the material of the plate (Page 54).

Art.No.			Geeignet für Thermocook Twin? Suitable for Thermocook Twin?	Material Material	Backzeit (ca.) Baking time (ca.)	Temperatur Temperature
31-40776-01	Pizza	Pizza	✗	Aluminium + Antihftb.	4-8 Min.	ca. 300°C
31-40775-01	Panini	Panini	✓	Aluminium + Antihftb.	2-3 Min.	ca. 180°C
31-40778-01	Waffel Burger	Waffle Burger	✓	Aluminium + Antihftb.	1,5 Min.	ca. 190°C
31-40765-01	Waffelschale	Waffle Bowls	✓	Aluminium + Antihftb.	2,5 Min.	ca. 185°C
32-40715-01	Brüsseler Waffel	Brussels Waffle	✓	Gusseisen	2,5 Min.	ca. 200°C
32-40742-01	Lorraine Waffel	Lorraine Waffle	✓	Gusseisen	3,2 Min.	ca. 180°C
32-40725-01	Kant Waffel	Kant Waffle	✓	Gusseisen	2,5 Min.	ca. 185°C
31-40733-01	Americano Waffel	Americano Waffle	✓	Aluminium + Antihftb.	3 Min.	ca. 180°C
32-40720-01	Große Herzwaffel	Big Heart Waffle	✓	Gusseisen	2 Min.	ca. 190°C
32-40747-01	Kleine Herzwaffel	Small Heart Waffle	✓	Gusseisen	2 Min.	ca. 190°C
31-40758-01	Sunny Waffel	Sunny Waffle	✓	Aluminium + Antihftb.	1,5 Min.	ca. 190°C
32-40732-01	Waffel-Taler	Waffle Coins	✓	Gusseisen	1,5 Min.	ca. 190°C
31-40759-01	Lolly-Waffel	Lolly Waffle	✗	Aluminium + Antihftb.	1 Min.	ca. 200°C
32-40769-01	Lolly-Waffel	Lolly Waffle	✗	Gusseisen	1 Min.	ca. 200°C
31-40731-01	Waffel-Bärchen am St.	Waffle Bears on a St.	✗	Aluminium + Antihftb.	1,5 Min.	ca. 190°C
32-40743-01	Rahmwaffel am St.	Cream Waffle on a St.	✗	Gusseisen	2,5 Min.	ca. 190°C
32-40744-01	Waffel-Herz am St.	Waffle Heart on a St.	✗	Gusseisen	3 Min.	ca. 180°C
32-40711-01	Stroopwaffel	Stroopwaffle	✓	Gusseisen	1 Min.	ca. 200°C
31-40761-01	Dony Donut	Dony Donut	✓	Aluminium + Antihftb.	3 Min.	ca. 170°C
31-40774-01	Crêpes	Crêpes	✗	Aluminium + Antihftb.	1 Min.	ca. 200°C
32-40772-01	Churros	Churros	✓	Gusseisen	1,5 Min.	ca. 170°C
31-40745-01	Mexican Snack	Mexican Snack	✓	Aluminium + Antihftb.	1,5 Min.	ca. 170°C
31-40748-01	Pancakes	Pancakes	✓	Aluminium + Antihftb.	1,5 Min.	ca. 170°C
31-40760-01	Waffelbälchen	Waffle Balls	✓	Aluminium + Antihftb.	2 Min.	ca. 190°C
31-40744-01	Sandwich	Sandwich	✓	Aluminium + Antihftb.	2 Min.	ca. 200°C
32-40704-01	X-Waffel	X-Waffle	✓	Gusseisen	1,5 Min.	ca. 180°C
32-40736-01	Waffeltörtchen	Waffle Tart	✓	Gusseisen	2,5 Min.	ca. 190°C
32-40710-01	Eiswaffel	Ice Cream Waffle	✓	Gusseisen	1 Min.	ca. 220°C

**NEU
NEW**



Wechsellplatten-Adapter-Set für Backsystem Interchangeable Plates Adapter Set for Baking System

Adapter-Set zur Verwendung von Thermocook Wechsellplatten auf dem Neumärker Backsystem • Sie besitzen bereits ein Neumärker Backsystem? Mit dem Adapter-Set können Sie auch weiterhin neue Wechselplatten auf Ihrem Gerät einsetzen • Kompatibel mit allen Wechsellplatten für den Thermocook • Kompatibel mit Neumärker Backsystem I + II (Art.No. 12-40701DT + 12-40702DT) • Beinhaltet 2 Kegel, 2 Spacer, 4 Schrauben • Je nach Modell der Wechselplatte wird der Kegel mit der kurzen Schraube verwendet oder der Kegel mit Spacer und der langen Schraube • Das Adapter-Set wird nicht für die Anwendung auf dem Neumärker Thermocook benötigt

Adapter set for using Thermocook interchangeable plates on the Neumärker Baking System • Do you already have a Neumärker baking system? With the adapter set, you can still use new interchangeable plates on your device • Compatible with all interchangeable plates for the Thermocook • Compatible with Neumärker baking system I + II (art. no. 12-40701DT + 12-40702DT) • Includes 2 cones, 2 spacers, 4 screws • Depending on the model of the interchangeable plate, the cone with the short screw is used or the cone with spacer and the long screw • The adapter set is not required for use on the Neumärker Thermocook

88-40701-00

€ 25,-* ▲